

**Sonda di temperatura per canale a immersione / con attacco filettato,
con uscita passiva**

Prodotto brevettato di qualità (Sonda a immersione brevetto n. DE 10 2012 017 500.0)

THERMASGARD® TF 43 è un termometro a resistenza con uscita passiva, involucro in plastica antiurto con coperchio a scatto, e tubo di protezione dritto.

THERMASGARD® TF 65 è un termometro a resistenza con uscita passiva, involucro in plastica antiurto con viti a chiusura rapida, e tubo di protezione dritto.

Le sonde di temperatura ad incasso / ad immersione sono termometri elettrici a contatto che servono per la misura delle temperature di liquidi e gas e vengono montate per es. in tubazioni e recipienti. Per sostanze aggressive usare pozzetti in acciaio inox. Il sensore di temperatura viene usato per es. in tubazioni, impianti di riscaldamento, serbatoi, stazioni compatte per teleriscaldamento, impianti di acqua calda e fredda, circuiti di olio e di lubrificazione, nella costruzione di macchine, apparecchi e impianti nonché in tutto l'ambito industriale.

DATI TECNICI

Range di misura:	-30...+150 °C (T _{max} NTC = +150 °C, T _{max} LM235Z = +125 °C)
Sensori / uscita:	vedere tabella, passiva (Perfect Sensor Protection) (come opzione anche con due sensori)
Tipo di comando:	collegamento a 2 conduttori (collegamento a 4 conduttori per PT100/PT1000A, opzionale per altri sensori)
Corrente di misura:	< 0,6 mA (Pt1000) < 1,0 mA (Pt100) < 0,3 mA (Ni1000, Ni1000 TK5000) < 2,0 mW (NTC xx) 400 µA...5 mA (LM235Z)
Resistenza di isolamento:	≥ 100 MΩ, a +20 °C (500 V DC)
Temperatura ambiente:	-20...+100 °C
Involucro:	plastica, resistente ai raggi UV, materiale poliammidico, rinforzato al 30% con sfere di vetro, colore bianco traffico (simile a RAL 9016) TF 43 con coperchio a scatto TF 65 con viti a chiusura rapida (combinazione con intaglio / impronta a croce)
Dimensioni involucro:	72 x 64 x 37,8 mm (Tyr 1 / Tyr 01)
Collegamento cavo:	avvitamento cavo in plastica (M 16 x 1,5; con scarico della trazione, intercambiabile, diametro interno max. 10,4 mm) o connettore M12 secondo DIN EN 61076-2-101 (come opzione su richiesta)
Collegamento elettrico:	0,14 - 1,5 mm ² , con morsetti a vite
Tubo di protezione:	acciaio inox V4A (1.4571), Ø = 6 mm, lunghezza di installazione (EL) = 50 - 400 mm (vedere tabella)
Umidità dell'aria consentita:	< 95 % u. r., aria senza condensa
Classe di protezione:	III (secondo EN 60 730)
Grado di protezione:	TF 43 IP 54 (secondo EN 60 529)* Involucro controllato, relazione TÜV SÜD n. 713160960A (Tyr 01) TF 65 IP 67 (secondo EN 60 529)* Involucro controllato, relazione TÜV SÜD n. 713139052 (Tyr 1) * Involucro montato

ACCESSORI

MF-15-K	Flangia di montaggio in plastica, 56,8 x 84,3 mm, Ø = 15,2 mm passatubo, T _{max} = +100 °C
TH08-MS-G/xx	Pozzetto a immersione in ottone pulito , Ø = 8 mm, T _{max} = +150 °C, p _{max} = 10 bar
TH08-VA/xx	Pozzetto a immersione in acciaio inox V4A (1.4571), Ø = 8 mm, T _{max} = +600 °C, p _{max} = 40 bar
TH08-VA/xx/90	Pozzetto a immersione in acciaio inox V4A (1.4571), con collo di estensione (90 mm), Ø = 8 mm, T _{max} = +600 °C, p _{max} = 40 bar

1x comando a due conduttori
Standard

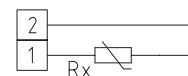

1x comando a due conduttori
LM235Z (KP 10)

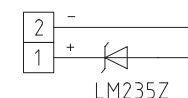

1x comando a quattro conduttori (come opzione)

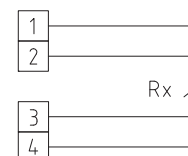

High-performance encapsulation against
vibration, mechanical stress and humidity





S+S REGELTECHNIK

THERMASGARD® TF 43
THERMASGARD® TF 65

Sonda di temperatura per canale a immersione / con attacco filettato,
con uscita passiva

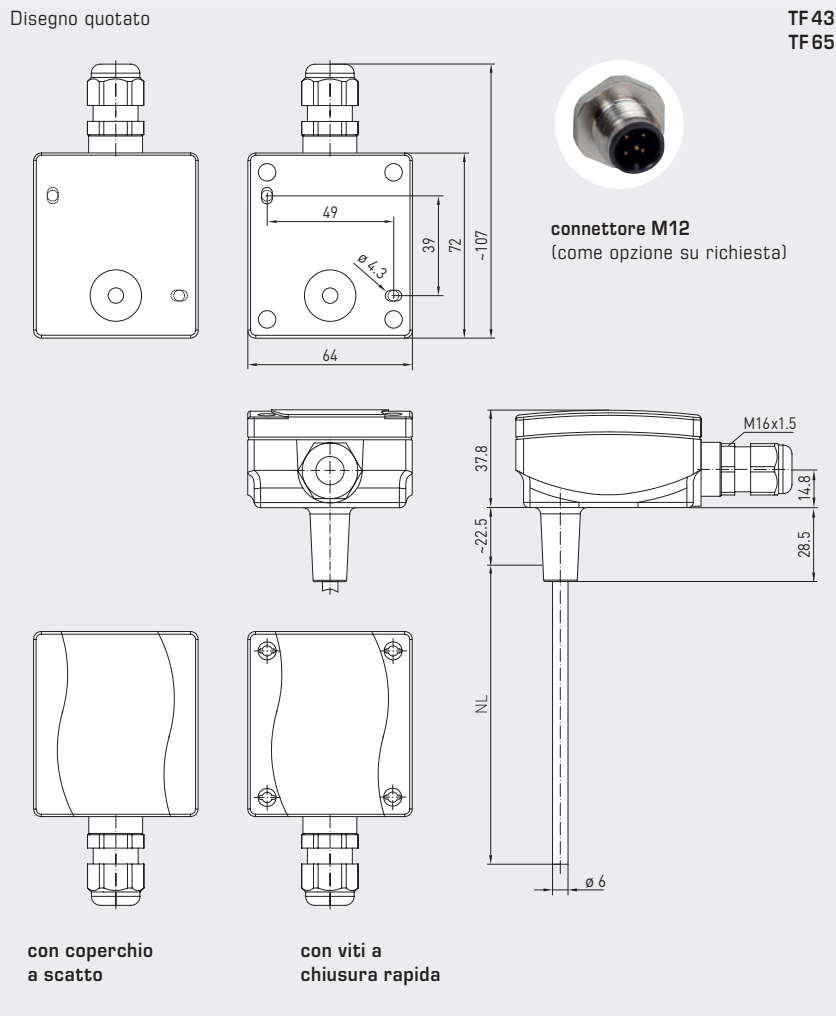

TF43
con coperchio a scatto
(IP54)



TF65
con viti a chiusura rapida
(IP67)



PATENTED



TFxx
strumento di base
con accessori

THERMASGARD® TF 65 Sensore di temperatura (Strumento di base con viti a chiusura rapida), *Premium*

Tipo / WG03 / EL	Sensore / uscita	N. art.	Prezzo
TF65 PT100 xx	Pt100	IP 67	
TF65 Pt100 50mm	Pt100 (secondo DIN EN 60 751, classe B)	1101-7020-1013-000	41,73 €
TF65 Pt100 100mm	Pt100 (secondo DIN EN 60 751, classe B)	1101-7020-1023-000	43,42 €
TF65 Pt100 150mm	Pt100 (secondo DIN EN 60 751, classe B)	1101-7020-1033-000	45,14 €
TF65 Pt100 200mm	Pt100 (secondo DIN EN 60 751, classe B)	1101-7020-1043-000	45,80 €
TF65 Pt100 250mm	Pt100 (secondo DIN EN 60 751, classe B)	1101-7020-1053-000	47,88 €
TF65 Pt100 300mm	Pt100 (secondo DIN EN 60 751, classe B)	1101-7020-1063-000	49,45 €
TF65 Pt100 350mm	Pt100 (secondo DIN EN 60 751, classe B)	1101-7020-1073-000	50,36 €
TF65 Pt100 400mm	Pt100 (secondo DIN EN 60 751, classe B)	1101-7020-1083-000	51,56 €
TF65 PT1000 xx	Pt1000	IP 67	
TF65 Pt1000 50mm	Pt1000 (secondo DIN EN 60 751, classe B)	1101-7020-5011-000	44,61 €
TF65 Pt1000 100mm	Pt1000 (secondo DIN EN 60 751, classe B)	1101-7020-5021-000	46,32 €
TF65 Pt1000 150mm	Pt1000 (secondo DIN EN 60 751, classe B)	1101-7020-5031-000	48,01 €
TF65 Pt1000 200mm	Pt1000 (secondo DIN EN 60 751, classe B)	1101-7020-5041-000	48,66 €
TF65 Pt1000 250mm	Pt1000 (secondo DIN EN 60 751, classe B)	1101-7020-5051-000	50,77 €
TF65 Pt1000 300mm	Pt1000 (secondo DIN EN 60 751, classe B)	1101-7020-5061-000	52,32 €
TF65 Pt1000 350mm	Pt1000 (secondo DIN EN 60 751, classe B)	1101-7020-5071-000	52,98 €
TF65 Pt1000 400mm	Pt1000 (secondo DIN EN 60 751, classe B)	1101-7020-5081-000	53,90 €
TF65 PT1000A xx	Pt1000A	IP 67	
TF65 Pt1000A 50mm	Pt1000 (secondo VDI/VDE 3512, classe A-TGA)	1101-7020-6013-000	46,75 €
TF65 Pt1000A 100mm	Pt1000 (secondo VDI/VDE 3512, classe A-TGA)	1101-7020-6023-000	47,49 €
TF65 Pt1000A 150mm	Pt1000 (secondo VDI/VDE 3512, classe A-TGA)	1101-7020-6033-000	49,99 €
TF65 Pt1000A 200mm	Pt1000 (secondo VDI/VDE 3512, classe A-TGA)	1101-7020-6043-000	50,63 €
TF65 Pt1000A 250mm	Pt1000 (secondo VDI/VDE 3512, classe A-TGA)	1101-7020-6053-000	52,73 €
TF65 Pt1000A 300mm	Pt1000 (secondo VDI/VDE 3512, classe A-TGA)	1101-7020-6063-000	54,41 €
TF65 Pt1000A 350mm	Pt1000 (secondo VDI/VDE 3512, classe A-TGA)	1101-7020-6073-000	56,12 €
TF65 Pt1000A 400mm	Pt1000 (secondo VDI/VDE 3512, classe A-TGA)	1101-7020-6083-000	56,36 €
TF65 Ni1000 xx	Ni 1000	IP 67	
TF65 Ni1000 50mm	Ni1000 (secondo DIN EN 43 760, classe B, TCR = 6180 ppm / K)	1101-7020-9011-000	43,83 €
TF65 Ni1000 100mm	Ni1000 (secondo DIN EN 43 760, classe B, TCR = 6180 ppm / K)	1101-7020-9021-000	45,92 €
TF65 Ni1000 150mm	Ni1000 (secondo DIN EN 43 760, classe B, TCR = 6180 ppm / K)	1101-7020-9031-000	47,62 €
TF65 Ni1000 200mm	Ni1000 (secondo DIN EN 43 760, classe B, TCR = 6180 ppm / K)	1101-7020-9041-000	48,27 €
TF65 Ni1000 250mm	Ni1000 (secondo DIN EN 43 760, classe B, TCR = 6180 ppm / K)	1101-7020-9051-000	50,36 €
TF65 Ni1000 300mm	Ni1000 (secondo DIN EN 43 760, classe B, TCR = 6180 ppm / K)	1101-7020-9061-000	51,92 €
TF65 Ni1000 350mm	Ni1000 (secondo DIN EN 43 760, classe B, TCR = 6180 ppm / K)	1101-7020-9071-000	52,98 €
TF65 Ni1000 400mm	Ni1000 (secondo DIN EN 43 760, classe B, TCR = 6180 ppm / K)	1101-7020-9081-000	53,64 €
TF65 NI1000TK xx	Ni1000 TK5000	IP 67	
TF65 NiTK 50mm	Ni1000 TK5000 (TCR = 5000 ppm / K), LG-Ni1000	1101-7021-0011-000	43,83 €
TF65 NiTK 100mm	Ni1000 TK5000 (TCR = 5000 ppm / K), LG-Ni1000	1101-7021-0021-000	45,92 €
TF65 NiTK 150mm	Ni1000 TK5000 (TCR = 5000 ppm / K), LG-Ni1000	1101-7021-0031-000	47,62 €
TF65 NiTK 200mm	Ni1000 TK5000 (TCR = 5000 ppm / K), LG-Ni1000	1101-7021-0041-000	48,27 €
TF65 NiTK 250mm	Ni1000 TK5000 (TCR = 5000 ppm / K), LG-Ni1000	1101-7021-0051-000	50,36 €
TF65 NiTK 300mm	Ni1000 TK5000 (TCR = 5000 ppm / K), LG-Ni1000	1101-7021-0061-000	51,92 €
TF65 NiTK 350mm	Ni1000 TK5000 (TCR = 5000 ppm / K), LG-Ni1000	1101-7021-0071-000	52,98 €
TF65 NiTK 400mm	Ni1000 TK5000 (TCR = 5000 ppm / K), LG-Ni1000	1101-7021-0081-000	48,97 €

Continua alla prossima pagina ...

High-performance encapsulation against
vibration, mechanical stress and humidity

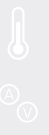

THERMASGARD® TF 65 Sensore di temperatura (Strumento di base con viti a chiusura rapida), Premium			
Tipo / WG03 / EL	Sensore / uscita	N. art.	Prezzo
TF65 LM235Z xx	LM235Z	IP67	
TF65 LM235Z 50mm	LM235Z (TCR = 10 mV / K; 2,73 V a 0 °C), KP10	1101-7022-1011-000	42,37 €
TF65 LM235Z 100mm	LM235Z (TCR = 10 mV / K; 2,73 V a 0 °C), KP10	1101-7022-1021-000	43,96 €
TF65 LM235Z 150mm	LM235Z (TCR = 10 mV / K; 2,73 V a 0 °C), KP10	1101-7022-1031-000	45,65 €
TF65 LM235Z 200mm	LM235Z (TCR = 10 mV / K; 2,73 V a 0 °C), KP10	1101-7022-1041-000	46,32 €
TF65 LM235Z 250mm	LM235Z (TCR = 10 mV / K; 2,73 V a 0 °C), KP10	1101-7022-1051-000	48,52 €
TF65 LM235Z 300mm	LM235Z (TCR = 10 mV / K; 2,73 V a 0 °C), KP10	1101-7022-1061-000	50,10 €
TF65 LM235Z 350mm	LM235Z (TCR = 10 mV / K; 2,73 V a 0 °C), KP10	1101-7022-1071-000	51,03 €
TF65 LM235Z 400mm	LM235Z (TCR = 10 mV / K; 2,73 V a 0 °C), KP10	1101-7022-1081-000	51,66 €
TF65 NTC 1,8K xx	NTC 1,8K	IP67	
TF65 NTC1,8K 50mm	NTC 1,8K	1101-7021-2011-000	40,05 €
TF65 NTC1,8K 100mm	NTC 1,8K	1101-7021-2021-000	41,73 €
TF65 NTC1,8K 150mm	NTC 1,8K	1101-7021-2031-000	43,42 €
TF65 NTC1,8K 200mm	NTC 1,8K	1101-7021-2041-000	43,96 €
TF65 NTC1,8K 250mm	NTC 1,8K	1101-7021-2051-000	46,16 €
TF65 NTC1,8K 300mm	NTC 1,8K	1101-7021-2061-000	47,74 €
TF65 NTC1,8K 350mm	NTC 1,8K	1101-7021-2071-000	48,60 €
TF65 NTC1,8K 400mm	NTC 1,8K	1101-7021-2081-000	49,72 €
TF65 NTC10K xx	NTC 10K	IP67	
TF65 NTC10K 50mm	NTC 10K	1101-7021-5011-000	40,05 €
TF65 NTC10K 100mm	NTC 10K	1101-7021-5021-000	41,73 €
TF65 NTC10K 150mm	NTC 10K	1101-7021-5031-000	43,42 €
TF65 NTC10K 200mm	NTC 10K	1101-7021-5041-000	43,96 €
TF65 NTC10K 250mm	NTC 10K	1101-7021-5051-000	46,16 €
TF65 NTC10K 300mm	NTC 10K	1101-7021-5061-000	47,74 €
TF65 NTC10K 350mm	NTC 10K	1101-7021-5071-000	48,60 €
TF65 NTC10K 400mm	NTC 10K	1101-7021-5081-000	49,72 €
TF65 NTC20K xx	NTC 20K	IP67	
TF65 NTC20K 50mm	NTC 20K	1101-7021-6011-000	40,05 €
TF65 NTC20K 100mm	NTC 20K	1101-7021-6021-000	41,73 €
TF65 NTC20K 150mm	NTC 20K	1101-7021-6031-000	43,42 €
TF65 NTC20K 200mm	NTC 20K	1101-7021-6041-000	43,96 €
TF65 NTC20K 250mm	NTC 20K	1101-7021-6051-000	46,04 €
TF65 NTC20K 300mm	NTC 20K	1101-7021-6061-000	47,74 €
TF65 NTC20K 350mm	NTC 20K	1101-7021-6071-000	48,60 €
TF65 NTC20K 400mm	NTC 20K	1101-7021-6081-000	49,72 €
Nota:	altri sensori come opzione	su richiesta	
Come opzione:	Collegamento cavo con connettore M12 secondo DIN EN 61076-2-101	su richiesta	



THERMASGARD® TF 43 Sensore di temperatura (Strumento di base con coperchio a scatto), *Standard*

Tipo / WG03 / EL	Sensore / uscita	N. art.	Prezzo
TF43 PT100 xx	Pt100	IP 54	
TF43 Pt100 50mm	Pt100 (secondo DIN EN 60 751, classe B)	1101-7010-1013-000	31,19 €
TF43 Pt100 100mm	Pt100 (secondo DIN EN 60 751, classe B)	1101-7010-1023-000	31,32 €
TF43 Pt100 150mm	Pt100 (secondo DIN EN 60 751, classe B)	1101-7010-1033-000	32,33 €
TF43 Pt100 200mm	Pt100 (secondo DIN EN 60 751, classe B)	1101-7010-1043-000	33,22 €
TF43 Pt100 250mm	Pt100 (secondo DIN EN 60 751, classe B)	1101-7010-1053-000	34,92 €
TF43 Pt100 300mm	Pt100 (secondo DIN EN 60 751, classe B)	1101-7010-1063-000	37,79 €
TF43 Pt100 350mm	Pt100 (secondo DIN EN 60 751, classe B)	1101-7010-1073-000	38,94 €
TF43 Pt100 400mm	Pt100 (secondo DIN EN 60 751, classe B)	1101-7010-1083-000	40,18 €
TF43 PT1000 xx	Pt1000	IP 54	
TF43 Pt1000 50mm	Pt1000 (secondo DIN EN 60 751, classe B)	1101-7010-5011-000	31,19 €
TF43 Pt1000 100mm	Pt1000 (secondo DIN EN 60 751, classe B)	1101-7010-5021-000	31,32 €
TF43 Pt1000 150mm	Pt1000 (secondo DIN EN 60 751, classe B)	1101-7010-5031-000	32,33 €
TF43 Pt1000 200mm	Pt1000 (secondo DIN EN 60 751, classe B)	1101-7010-5041-000	33,22 €
TF43 Pt1000 250mm	Pt1000 (secondo DIN EN 60 751, classe B)	1101-7010-5051-000	34,92 €
TF43 Pt1000 300mm	Pt1000 (secondo DIN EN 60 751, classe B)	1101-7010-5061-000	37,79 €
TF43 Pt1000 350mm	Pt1000 (secondo DIN EN 60 751, classe B)	1101-7010-5071-000	38,94 €
TF43 Pt1000 400mm	Pt1000 (secondo DIN EN 60 751, classe B)	1101-7010-5081-000	40,18 €
TF43 PT1000A xx	Pt1000A	IP 54	
TF43 Pt1000A 50mm	Pt1000 (secondo VDI/VDE 3512, classe A-TGA)	1101-7010-6013-000	33,15 €
TF43 Pt1000A 100mm	Pt1000 (secondo VDI/VDE 3512, classe A-TGA)	1101-7010-6023-000	33,30 €
TF43 Pt1000A 150mm	Pt1000 (secondo VDI/VDE 3512, classe A-TGA)	1101-7010-6033-000	34,28 €
TF43 Pt1000A 200mm	Pt1000 (secondo VDI/VDE 3512, classe A-TGA)	1101-7010-6043-000	35,18 €
TF43 Pt1000A 250mm	Pt1000 (secondo VDI/VDE 3512, classe A-TGA)	1101-7010-6053-000	36,87 €
TF43 Pt1000A 300mm	Pt1000 (secondo VDI/VDE 3512, classe A-TGA)	1101-7010-6063-000	39,75 €
TF43 Pt1000A 350mm	Pt1000 (secondo VDI/VDE 3512, classe A-TGA)	1101-7010-6073-000	40,92 €
TF43 Pt1000A 400mm	Pt1000 (secondo VDI/VDE 3512, classe A-TGA)	1101-7010-6083-000	42,16 €
TF43 Ni1000 xx	Ni1000	IP 54	
TF43 Ni1000 50mm	Ni1000 (secondo DIN EN 43 760, classe B, TCR = 6180 ppm/K)	1101-7010-9011-000	31,96 €
TF43 Ni1000 100mm	Ni1000 (secondo DIN EN 43 760, classe B, TCR = 6180 ppm/K)	1101-7010-9021-000	34,99 €
TF43 Ni1000 150mm	Ni1000 (secondo DIN EN 43 760, classe B, TCR = 6180 ppm/K)	1101-7010-9031-000	35,25 €
TF43 Ni1000 200mm	Ni1000 (secondo DIN EN 43 760, classe B, TCR = 6180 ppm/K)	1101-7010-9041-000	36,01 €
TF43 Ni1000 250mm	Ni1000 (secondo DIN EN 43 760, classe B, TCR = 6180 ppm/K)	1101-7010-9051-000	37,03 €
TF43 Ni1000 300mm	Ni1000 (secondo DIN EN 43 760, classe B, TCR = 6180 ppm/K)	1101-7010-9061-000	39,46 €
TF43 Ni1000 350mm	Ni1000 (secondo DIN EN 43 760, classe B, TCR = 6180 ppm/K)	1101-7010-9071-000	40,59 €
TF43 Ni1000 400mm	Ni1000 (secondo DIN EN 43 760, classe B, TCR = 6180 ppm/K)	1101-7010-9081-000	42,41 €
TF43 NI1000TK xx	Ni1000 TK5000	IP 54	
TF43 NiTK 50mm	Ni1000 TK5000 (TCR = 5000 ppm/K), LG-Ni1000	1101-7011-0011-000	32,02 €
TF43 NiTK 100mm	Ni1000 TK5000 (TCR = 5000 ppm/K), LG-Ni1000	1101-7011-0021-000	35,05 €
TF43 NiTK 150mm	Ni1000 TK5000 (TCR = 5000 ppm/K), LG-Ni1000	1101-7011-0031-000	35,41 €
TF43 NiTK 200mm	Ni1000 TK5000 (TCR = 5000 ppm/K), LG-Ni1000	1101-7011-0041-000	36,16 €
TF43 NiTK 250mm	Ni1000 TK5000 (TCR = 5000 ppm/K), LG-Ni1000	1101-7011-0051-000	37,15 €
TF43 NiTK 300mm	Ni1000 TK5000 (TCR = 5000 ppm/K), LG-Ni1000	1101-7011-0061-000	39,62 €
TF43 NiTK 350mm	Ni1000 TK5000 (TCR = 5000 ppm/K), LG-Ni1000	1101-7011-0071-000	40,86 €
TF43 NiTK 400mm	Ni1000 TK5000 (TCR = 5000 ppm/K), LG-Ni1000	1101-7011-0081-000	42,57 €

Continua alla prossima pagina ...

High-performance encapsulation against
vibration, mechanical stress and humidity



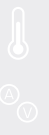

THERMASGARD® TF 43 Sensore di temperatura (Strumento di base con coperchio a scatto), Standard			
Tipo / WG03 / EL	Sensore / uscita	N. art.	Prezzo
TF43 LM235Z xx	LM235Z	IP54	
TF43 LM235Z 50mm	LM235Z (TCR = 10 mV / K; 2,73 V a 0°C), KP10	1101-7012-1011-000	32,60 €
TF43 LM235Z 100mm	LM235Z (TCR = 10 mV / K; 2,73 V a 0°C), KP10	1101-7012-1021-000	32,95 €
TF43 LM235Z 150mm	LM235Z (TCR = 10 mV / K; 2,73 V a 0°C), KP10	1101-7012-1031-000	34,13 €
TF43 LM235Z 200mm	LM235Z (TCR = 10 mV / K; 2,73 V a 0°C), KP10	1101-7012-1041-000	34,92 €
TF43 LM235Z 250mm	LM235Z (TCR = 10 mV / K; 2,73 V a 0°C), KP10	1101-7012-1051-000	35,32 €
TF43 LM235Z 300mm	LM235Z (TCR = 10 mV / K; 2,73 V a 0°C), KP10	1101-7012-1061-000	38,35 €
TF43 LM235Z 350mm	LM235Z (TCR = 10 mV / K; 2,73 V a 0°C), KP10	1101-7012-1071-000	38,82 €
TF43 LM235Z 400mm	LM235Z (TCR = 10 mV / K; 2,73 V a 0°C), KP10	1101-7012-1081-000	41,24 €
TF43 NTC 1,8K xx	NTC 1,8K	IP54	
TF43 NTC1,8K 50mm	NTC 1,8K	1101-7011-2011-000	31,19 €
TF43 NTC1,8K 100mm	NTC 1,8K	1101-7011-2021-000	32,88 €
TF43 NTC1,8K 150mm	NTC 1,8K	1101-7011-2031-000	33,72 €
TF43 NTC1,8K 200mm	NTC 1,8K	1101-7011-2041-000	34,51 €
TF43 NTC1,8K 250mm	NTC 1,8K	1101-7011-2051-000	36,16 €
TF43 NTC1,8K 300mm	NTC 1,8K	1101-7011-2061-000	37,37 €
TF43 NTC1,8K 350mm	NTC 1,8K	1101-7011-2071-000	38,63 €
TF43 NTC1,8K 400mm	NTC 1,8K	1101-7011-2081-000	39,62 €
TF43 NTC10K xx	NTC 10K	IP54	
TF43 NTC10K 50mm	NTC 10K	1101-7011-5011-000	31,19 €
TF43 NTC10K 100mm	NTC 10K	1101-7011-5021-000	32,88 €
TF43 NTC10K 150mm	NTC 10K	1101-7011-5031-000	33,72 €
TF43 NTC10K 200mm	NTC 10K	1101-7011-5041-000	34,51 €
TF43 NTC10K 250mm	NTC 10K	1101-7011-5051-000	36,16 €
TF43 NTC10K 300mm	NTC 10K	1101-7011-5061-000	37,37 €
TF43 NTC10K 350mm	NTC 10K	1101-7011-5071-000	38,63 €
TF43 NTC10K 400mm	NTC 10K	1101-7011-5081-000	39,62 €
TF43 NTC20K xx	NTC 20K	IP54	
TF43 NTC20K 50mm	NTC 20K	1101-7011-6011-000	31,19 €
TF43 NTC20K 100mm	NTC 20K	1101-7011-6021-000	32,88 €
TF43 NTC20K 150mm	NTC 20K	1101-7011-6031-000	33,72 €
TF43 NTC20K 200mm	NTC 20K	1101-7011-6041-000	34,51 €
TF43 NTC20K 250mm	NTC 20K	1101-7011-6051-000	36,16 €
TF43 NTC20K 300mm	NTC 20K	1101-7011-6061-000	37,37 €
TF43 NTC20K 350mm	NTC 20K	1101-7011-6071-000	38,63 €
TF43 NTC20K 400mm	NTC 20K	1101-7011-6081-000	39,62 €
Nota:	altri sensori come opzione	su richiesta	
Come opzione:	Collegamento cavo con connettore M12 secondo DIN EN 61076-2-101	su richiesta	



Sonda di temperatura per canale a immersione / con attacco filettato,
 con uscita passiva

Un apparecchio di base in quattro varianti...



PATENTED
 DE 10 2012 017 500.0

**TFxx +
 TH08-MS-G/xx**

Trasmettitori di temperatura a immersione / con attacco filettato con pozzetto a immersione in ottone pulito

**TFxx +
 TH08-VA/xx**

Trasmettitori di temperatura a immersione / con attacco filettato con pozzetto a immersione in acciaio inox V4A

**TFxx +
 TH08-VA/xx/90**

Trasmettitori di temperatura a immersione / con attacco filettato con pozzetto a immersione con collo di estensione in acciaio inox V4A

**TFxx +
 MF-15-K**

Sonda di temperatura per canale con flangia di montaggio in plastica

TH08-MS-G/xx
 Disegno quotato [mm]

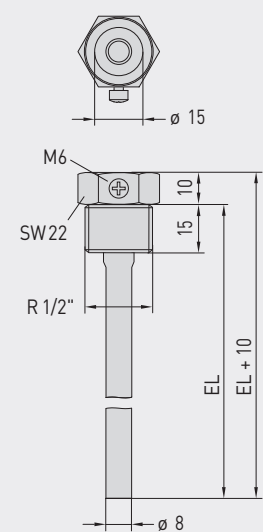

TH08-VA/xx
 Disegno quotato [mm]

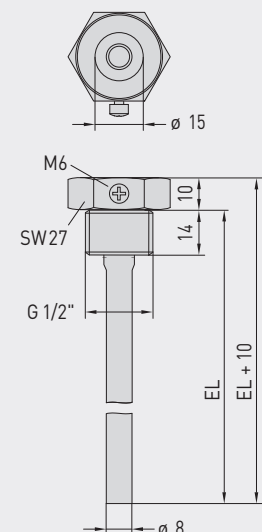

TH08-VA/xx/90
 Disegno quotato [mm]

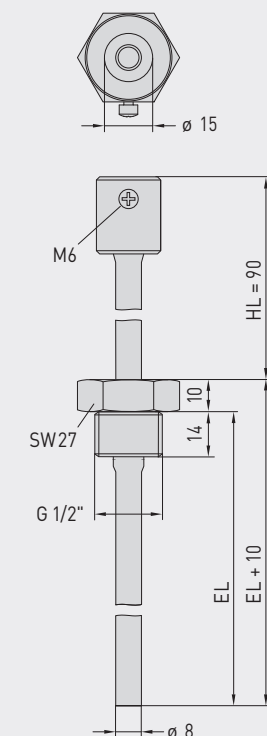

MF-15-K
 Disegno quotato [mm]

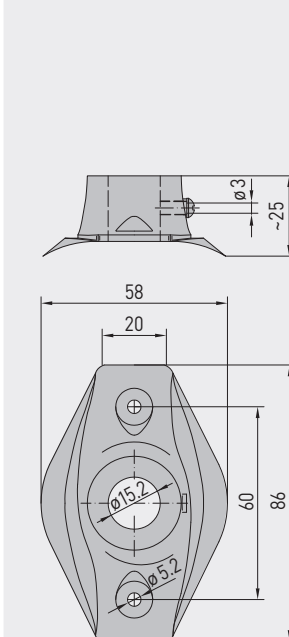



S+S REGELTECHNIK

THERMASGARD® TF 43
THERMASGARD® TF 65

Sonda di temperatura per canale a immersione / con attacco filettato,
con uscita passiva

...grazie alla combinazione degli accessori:



TH08-MS-G/xx

Pozzetto a immersione in ottone pulito, a tenuta filettata, conica, secondo DIN 10226



TH08-VA/xx

Pozzetto a immersione in acciaio inox V4A, a tenuta piana, cilindrica, secondo DIN 228



TH08-VA/xx/90

Pozzetto a immersione con collo di estensione in acciaio inox V4A, a tenuta piana, cilindrica, secondo DIN 228



MF-15-K

Flangia di montaggio in plastica

THERMASGARD® TH08		Pozzetto a immersione Ø 8 mm (Accessori)			
Tipo / WG01B	p _{max} (statica)	T _{max}	Lunghezza di installazione (EL)	N. art.	Prezzo
TH08-MS-G xx		Ottone pulito			
senza collo di estensione					
TH08-MS-G 50MM	10 bar	+150 °C	50 mm	7100-0017-0010-132	13,82 €
TH08-MS-G 100MM	10 bar	+150 °C	100 mm	7100-0017-0020-132	14,46 €
TH08-MS-G 150MM	10 bar	+150 °C	150 mm	7100-0017-0030-132	15,64 €
TH08-MS-G 200MM	10 bar	+150 °C	200 mm	7100-0017-0040-132	16,73 €
TH08-MS-G 250MM	10 bar	+150 °C	250 mm	7100-0017-0050-132	19,37 €
TH08-MS-G 300MM	10 bar	+150 °C	300 mm	7100-0017-0060-132	20,25 €
TH08-MS-G 350MM	10 bar	+150 °C	350 mm	7100-0017-0070-132	20,79 €
TH08-MS-G 400MM	10 bar	+150 °C	400 mm	7100-0017-0080-132	21,32 €
TH08-VA/xx		Acciaio inox V4A (1.4571)			
senza collo di estensione					
TH08-VA 50MM	40 bar	+600 °C	50 mm	7100-0012-0010-132	23,82 €
TH08-VA 100MM	40 bar	+600 °C	100 mm	7100-0012-0020-132	26,24 €
TH08-VA 150MM	40 bar	+600 °C	150 mm	7100-0012-0030-132	28,39 €
TH08-VA 200MM	40 bar	+600 °C	200 mm	7100-0012-0040-132	29,78 €
TH08-VA 250MM	40 bar	+600 °C	250 mm	7100-0012-0050-132	37,06 €
TH08-VA 300MM	40 bar	+600 °C	300 mm	7100-0012-0060-132	38,78 €
TH08-VA 350MM	40 bar	+600 °C	350 mm	7100-0012-0070-132	39,53 €
TH08-VA 400MM	40 bar	+600 °C	400 mm	7100-0012-0080-132	40,60 €
TH08-VA/xx/90		Acciaio inox V4A (1.4571)			
con collo di estensione (90mm)					
TH08-VA 50/90MM	40 bar	+600 °C	50 mm	7100-0012-0012-132	32,04 €
TH08-VA 100/90MM	40 bar	+600 °C	100 mm	7100-0012-0022-132	33,49 €
TH08-VA 150/90MM	40 bar	+600 °C	150 mm	7100-0012-0032-132	35,13 €
TH08-VA 200/90MM	40 bar	+600 °C	200 mm	7100-0012-0042-132	36,63 €
TH08-VA 250/90MM	40 bar	+600 °C	250 mm	7100-0012-0052-132	38,38 €
TH08-VA 300/90MM	40 bar	+600 °C	300 mm	7100-0012-0062-132	41,60 €
Nota:		diametro interno dell'alloggiamento 15,0mm Per ulteriori informazioni vedere l'ultimo capitolo!			
Flangia di montaggio (Accessori)					
Tipo / WG01B		T _{max}	N. art.	Prezzo	
MF					
MF-15-K	Flangia di montaggio in plastica, 56,8x84,3mm, Ø 15,2mm passatubo		+100 °C	7100-0032-0000-000	6,75 €
Nota:		Per ulteriori informazioni vedere l'ultimo capitolo!			